

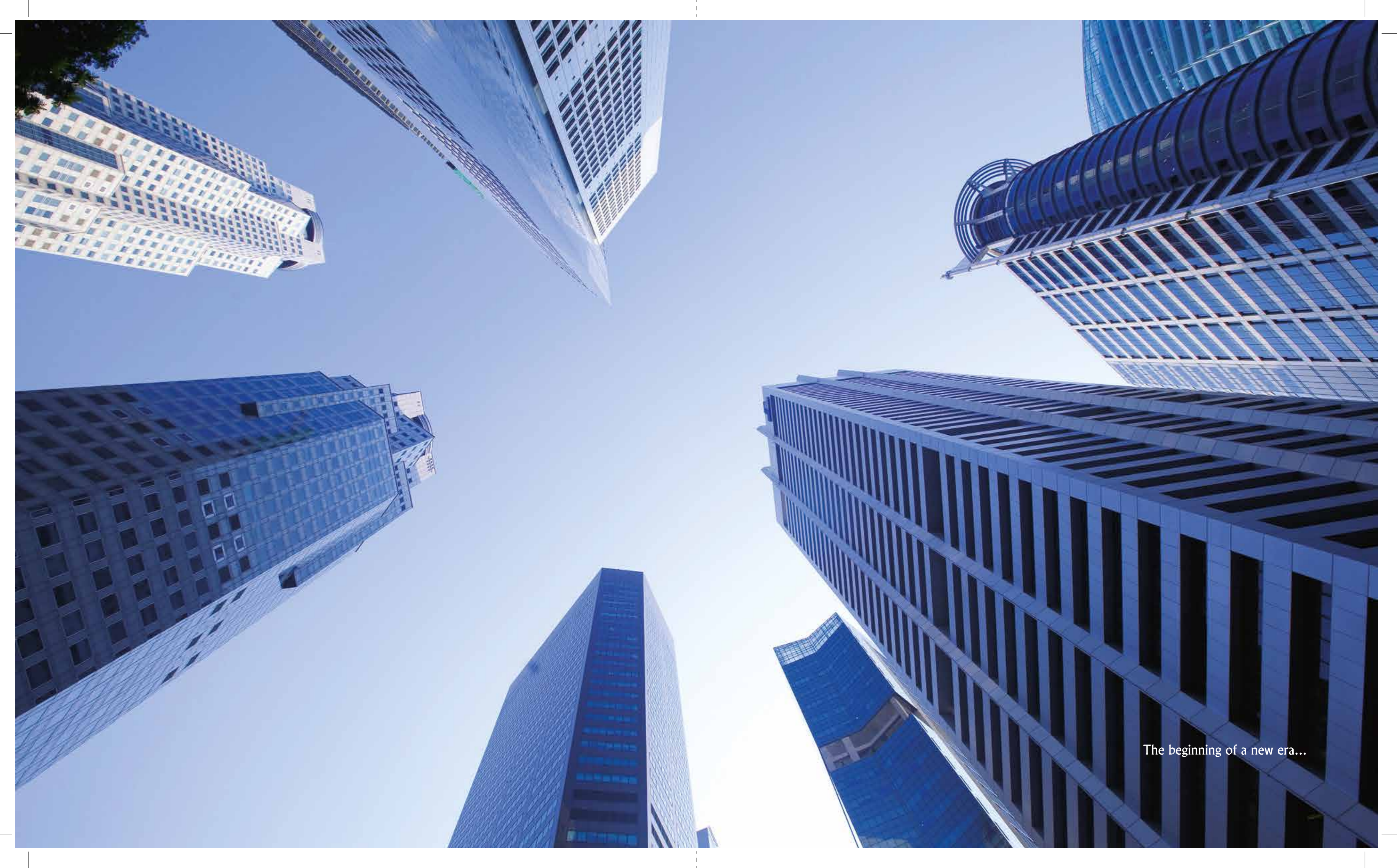

CAMRY

CAMRY

manhattan



The beginning of a new era...

Poetry in Motion

It is a philosophy that is guided by desire taking the perfect art form. We have taken an approach where nature's inspiration can be glimpsed in every curve and contour of the automobile. The Camry represents pure art skillfully moulded into perfection. Every curve as deliberate as it is desired. Every detail as inspired as it is intricate.





Unrivalled Design

Design that goes beyond a mere facelift. With sensational curves and an uplifted hood, the Camry displays its bold character and supreme strength. The grille features a horizontal chrome bar with an exquisite crystal droplet design.



Linear precision that accentuates futuristic appeal.

Brilliant Precision

Like a multi-faceted jewel, polished to perfection and cut with precision. A sharply defined, trailing edge that gives an endless, aerodynamic feel and performance.





Bridging the distance between promise and fulfillment.



Merging contemporary style and bold character.



Exhilarating Performance

Feel the tempo of exhilaration as you cruise to perfection with dynamic performance that resonates. An optimal blend of aerodynamic power with perfect fuel economy, Camry gives new meaning to your driving pleasure.



Fusing dramatic appeal with a dynamic perspective.



Timeless Elegance

The All New Camry reveals breathtaking attention to detail with integrated systems and unparalleled interior design. A low set, horizontal T-shaped instrument panel ensures ergonomic ease and prestigious appeal. Luxury shell, leather seats give physical form to the Camry experience.



Wooden, mahogany panelling for a luxurious and fascinating feel.

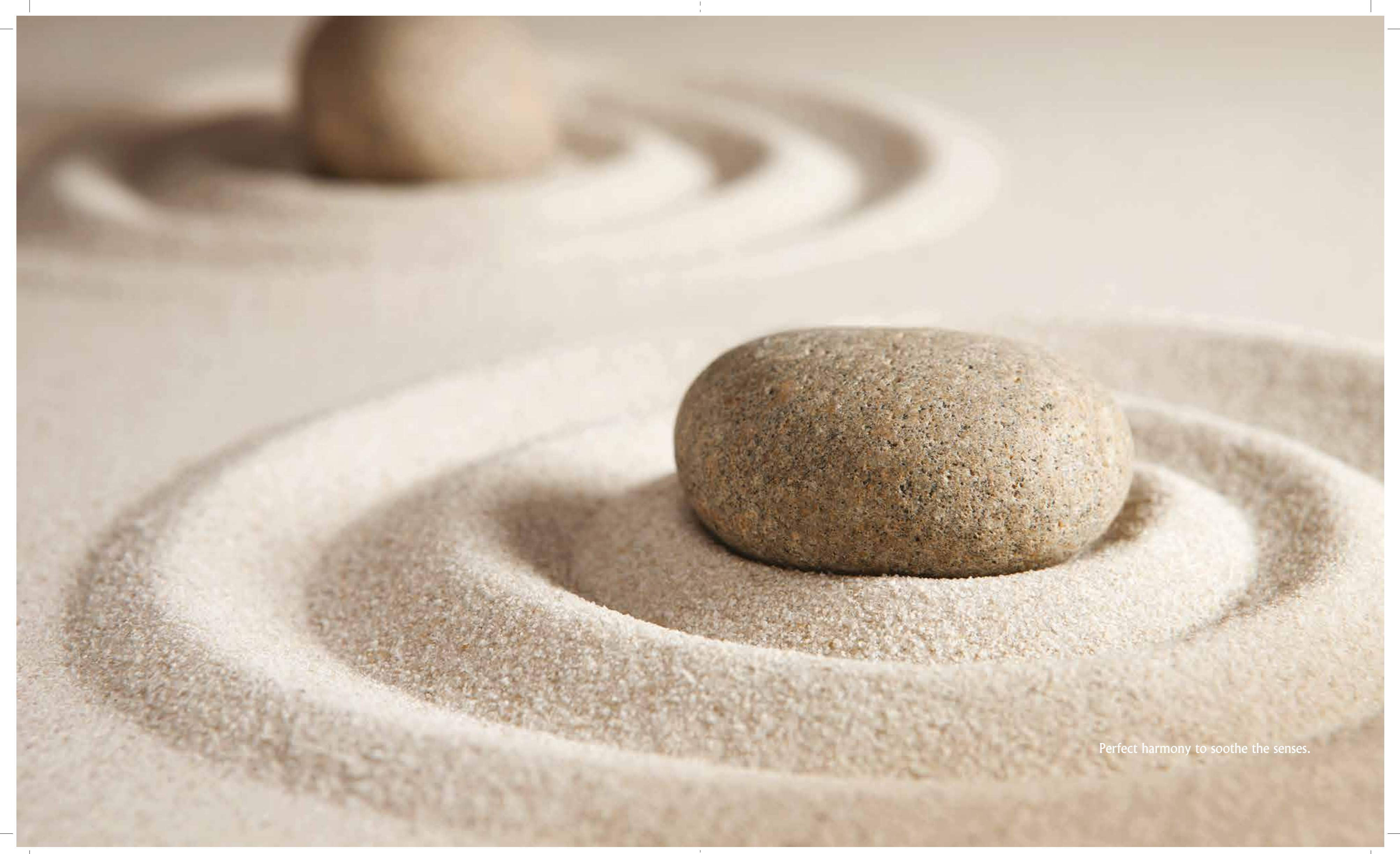

Perfect harmony to soothe the senses.

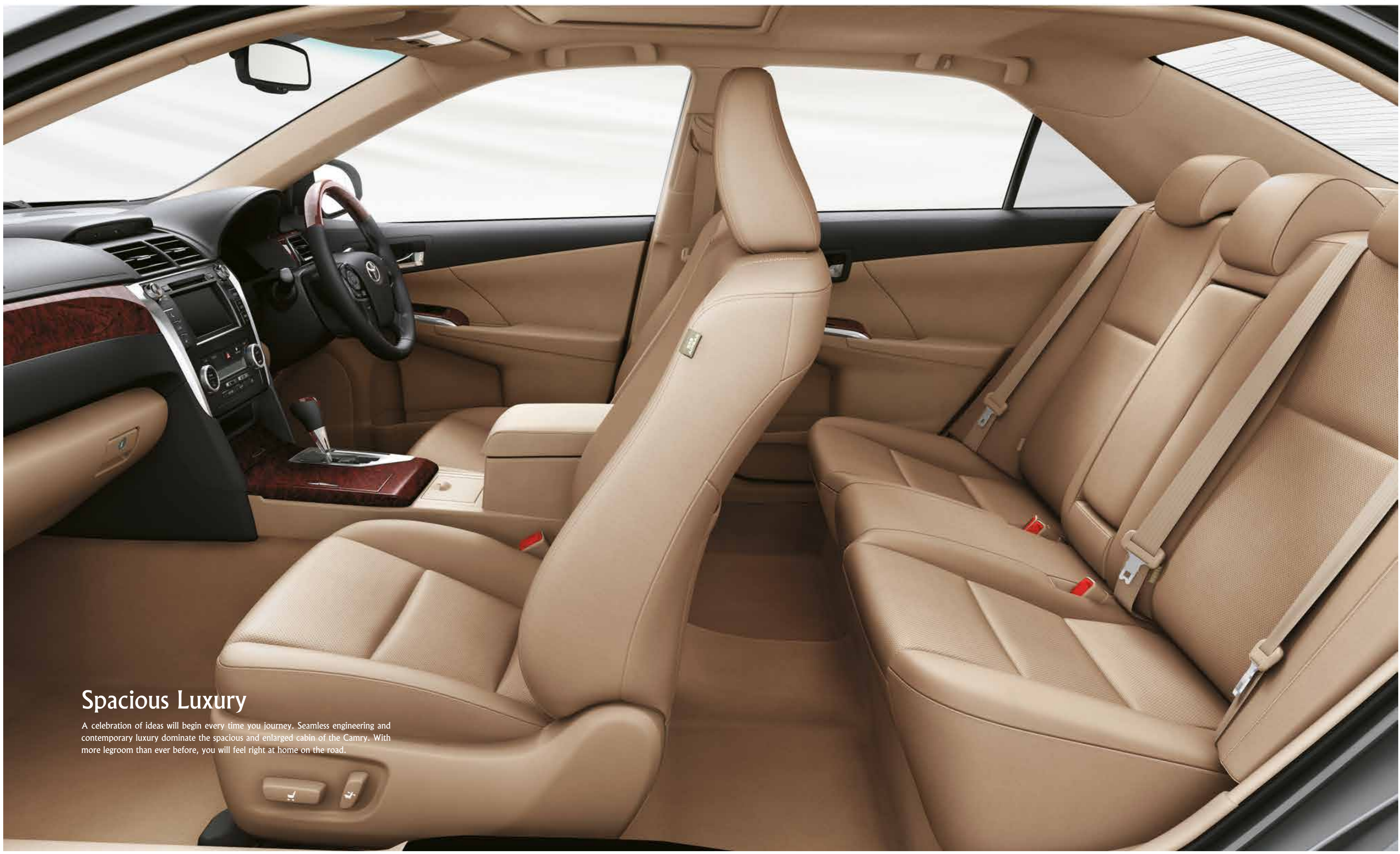

Spacious Luxury

A celebration of ideas will begin every time you journey. Seamless engineering and contemporary luxury dominate the spacious and enlarged cabin of the Camry. With more legroom than ever before, you will feel right at home on the road.

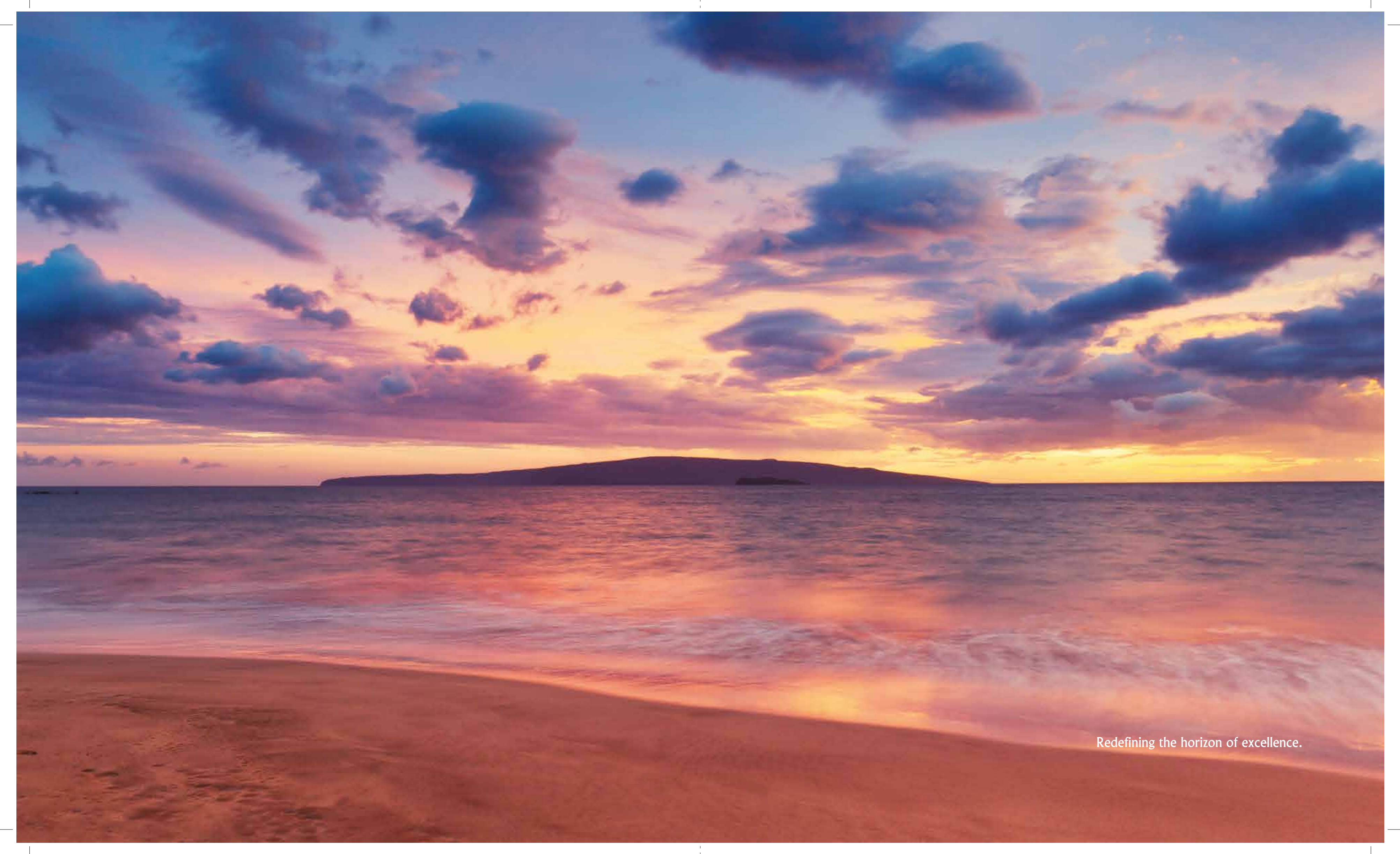

Redefining the horizon of excellence.



Artful Discretion

Powerful engine. Thoughtful design. You can feel the roar of the powerful 2.5L VVT-i engine but you won't hear it with our noise-damping cabin lining and windshield. Designed to prevent noise from entering the cabin, you can always be assured of the highest levels of sound insulation and discretion.



Extraordinary Pleasure

The Camry experience lingers long after you reach your destination. Taking you to places beyond the ordinary. Your Camry, extraordinary.

CAMRY

Mark your arrival into a new age with the All New Camry. Based on a philosophy that redefines excellence; our new age sedan offers unsurpassed levels of performance, comfort and luxury. Experience a new world of comfortable adventure. Revel in the glory of undeniable luxury. Open up to a road of endless possibilities...

Performance

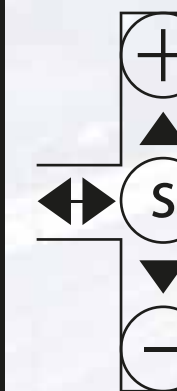
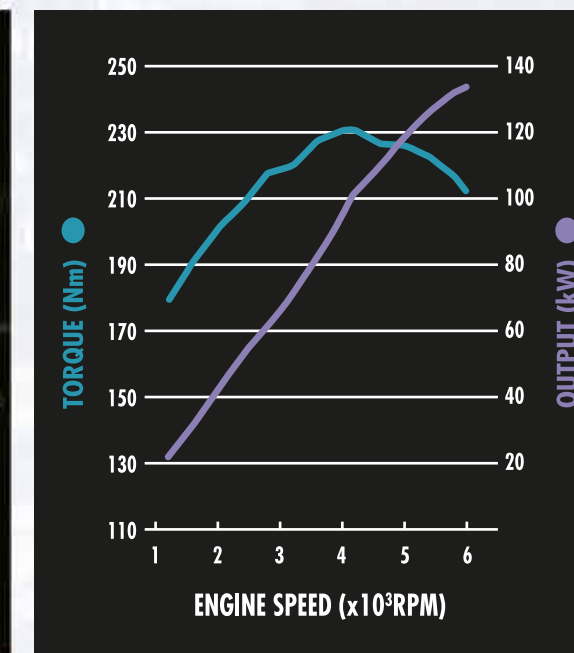

Engine
Fuel economy, low emission and unsurpassed quietness are just a few hallmarks of the new Camry. Equipped with a 2.5L 2AR-FE Dual VVT-i engine and light-weight, low emission TCV (Tumble Control Valves) for outstanding performance. The unique ACIS (Acoustic Control Induction System) ensures optimum power and torque, particularly at low speeds.

Transmission
Intelligent multi-mode 6-speed automatic transmission enables manual-like gear shifting by using the + (UP)/-(DOWN) shift switches in the 'S' position. Camry's 6-speed automatic transmission provides the added advantages of excellent starting acceleration, fuel economy, smooth gear shifting and driving performance.

Utility & Comfort



Dual Cabin A/C

Camry offers exceptional passenger comfort with a dual cabin, automatic air conditioning system. Equipped with a 3-zone temperature control and 'nanoe™' air purifying technology. Nanoe™ particles inhibit bacteria and viruses, improve air quality, and prevent skin moisture loss resulting from air conditioned environments.



Audio System and 6 Speaker Surround Sound

A 6.1-inch EGA TFT touch panel in dash audio graces the instrument panel. The touch panel display is equipped with auxiliary input jacks compatible with iPod, USB, and Bluetooth devices. Six speakers located across the cabin ensure optimum acoustic performance.

A 4-way directional button is located on the steering wheel for operational accessibility. Audio system and Bluetooth hands-free phones can also be operated using the 4-way directional button.



Steering Wheel

Camry's wood grain finished, urethane-type four-spoke steering wheel is encased in genuine, premium leather. Audio and voice recognition switches are located on the right. The audio switches on the steering wheel are arranged in a cross shape, allowing maximum utility to the driver.



Spaciousness

Camry has superb spaciousness with specially redesigned seats to provide excellent legroom and cabin comfort. The cabin has been designed with a view to ergonomics, comfort and luxury.

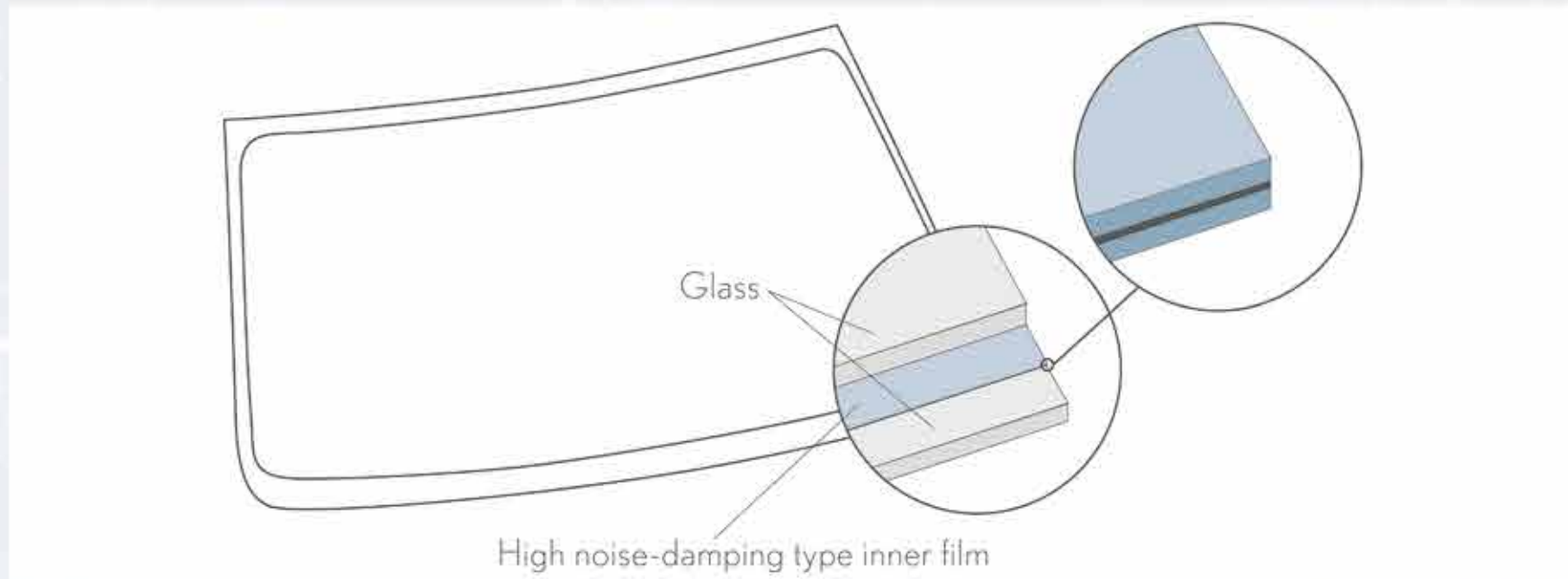

Noise Damping Foil

Acoustic glass noise prevention film interlaid between the two layers of the windshield ensures optimum quietness.

Safety



Camry's VSC (Vehicle Stability Control) is specially designed to manage over-steering and under-steering at every turn to guarantee excellent stability by varying engine output and braking force.

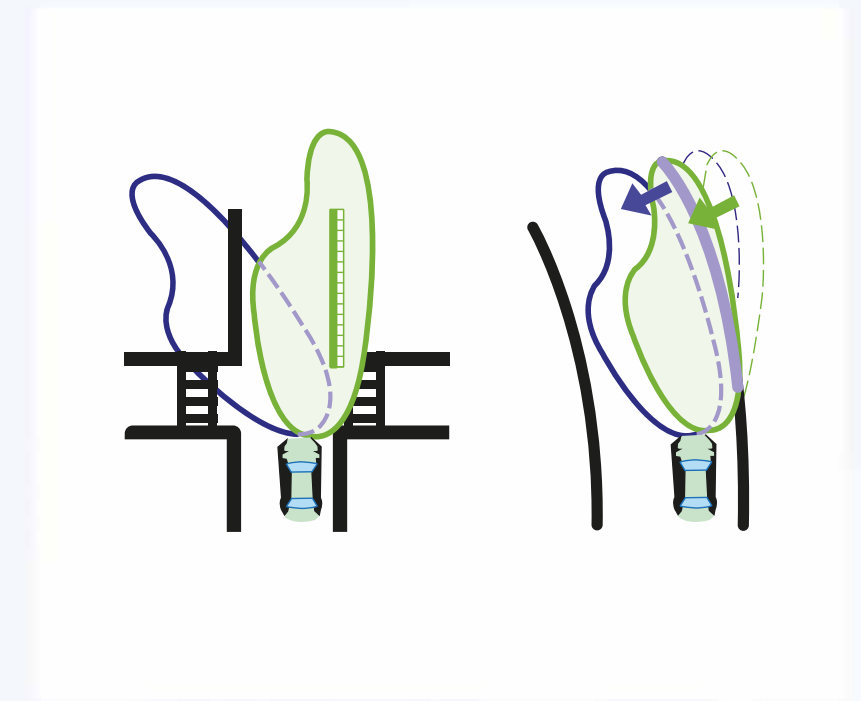

Camry's AFS (Adaptive Front Lighting System) technology changes the headlamp beam direction in response to steering operations, increasing visibility at intersections and turnings.



WIL (Whiplash Injury Lessening) concept seats prevent sudden jerks to the neck in the event of a rear end collision to reduce whiplash injury.



Camry's impact absorbing body is designed to disperse and absorb collision energy to control excessive cabin deformation and ensure passenger safety.

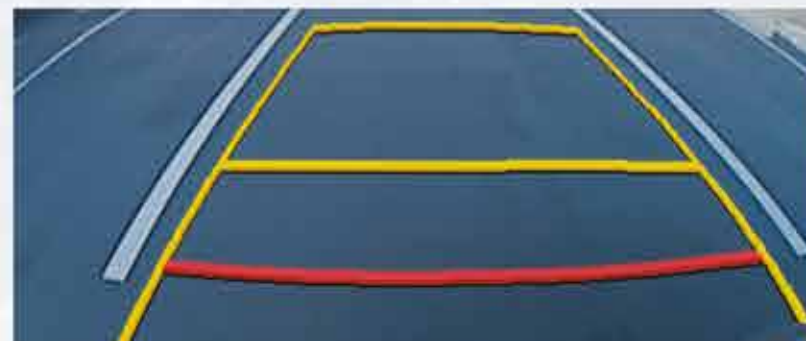

The Back Guide Monitor displays video on the display screen allowing confirmation of obstacles behind the vehicle. In addition to the image of the area behind the vehicle, the vehicle direction in response to steering input is also displayed.



SRS (Supplemental Restraint System) airbags for the driver, front passenger seat, sides and curtain shields help reduce the collision energy imparted to occupants in the event of a collision.

Main Features

Exterior

Windshield Green Glass with Rain Sensors
 Door Wind Glass; UV cut with Water Repellent
 Power Door Mirrors; Retractable Wide View Type with Aero Stabilising Fins on base
 Fog Lamps with Chrome Finishing

Interior

Optitron Meters with Multipurpose LCD Display
 Power Windows
 Cup-holders (Front seats and rear central armrest)
 Auto 3-zone Airconditioning with Nanoe Technology
 Leather Steering Wheel with Wooden Panelling
 Wood Panel and Trim
 Partial Leather Interior

Operation

EPS Steering Wheel
 Steering Wheel Control Switches; Audio System, Hands-free Phone
 Memory Switches for the Front Seats
 Cruise Control
 Push Start System
 Keyless Entry

Audio

Display Audio System, 6.1 inch EGA TFT Touch Panel, iPod, USB, Bluetooth Compatible with Steering Switch Operability

Safety

VSC (Vehicle Stability Control)
 ABS (Anti-lock Brake System) with EBD (Electronic Brake-force Distribution)
 AFS (Adaptive Front-lighting System)
 SRS (Supplemental Restraint System) Airbags
 WIL (Whiplash Injury Lessening) Concept Seats
 GOA (Global Outstanding Assessment) Body

Colour Range



Specifications

Dimensions and Weight

Overall Length		4825	mm
Overall Width		1825	mm
Overall Height		1480	mm
Wheelbase		2775	mm
Tread	Front	1570	mm
	Rear	1580	mm
Kerb Weight		1435	kg
Gross Vehicle Weight		2100	kg

Chassis

Suspension:			
MacPherson Strut / Dual Link			
Steering System:			
Rack and Pinion, EPS Column Mount			
Brakes	Front	296 mm Ventilated Disk	
	Rear	281 mm Solid Disk	
Minimum Turning Radius			
70 litre			
Fuel Tank Capacity			
215/60R16 SM			
Tyres			
Engine:			
Type	2AR-FE		
Piston Displacement	2494	cm ³	
Max. Output	133 / 6000	kW/RPM	
Max. Torque	231 / 4100	Nm/RPM	
Fuel System	Intake Port (Multi Point)		

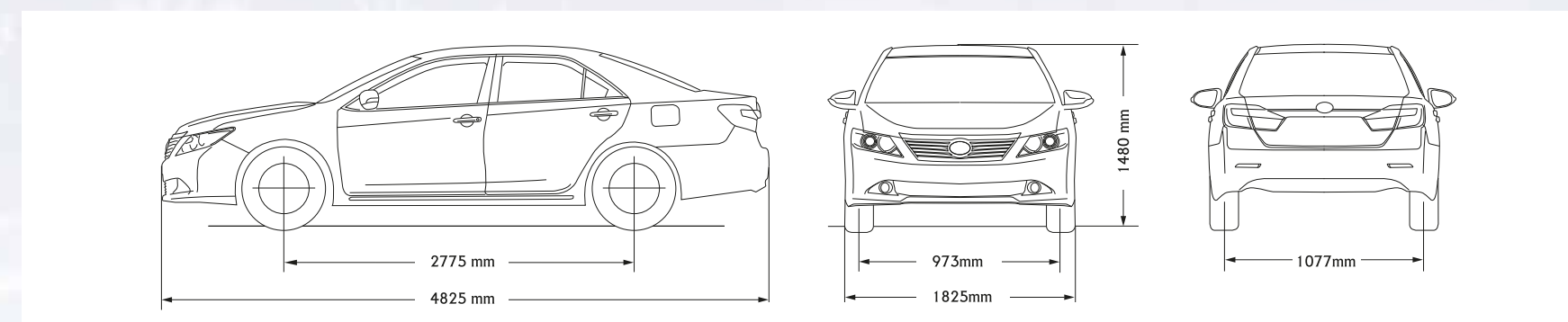

Disclaimer: Features and specifications shown in visuals may differ from actual vehicle.